

User Manual

SCT-IPKVM-TX131

SCT-IPKVM-RX141

HDMI over IP Extender



Version: V1.0.0



Important Safety Instructions

Note

In case of any content change, we are sorry for no further notice.

Warning

To reduce the risk of fire, electric shock or product damage:



1. Do not expose this apparatus to rain, moisture, dripping or splashing and that no objects filled with liquids, such as vases, shall be placed on the apparatus.



6. Clean this apparatus only with dry cloth.



2. Do not install or place this unit in a bookcase, built-in cabinet or in another confined space. Ensure the unit is well ventilated.



7. Unplug this apparatus during lightning storms or when unused for long periods of time.



3. To prevent risk of electric shock or fire hazard due to overheating, do not obstruct the unit's ventilation openings with newspapers, tablecloths, curtains, and similar items.



8. Protect the power cord from being walked on or pinched particularly at plugs.



4. Do not install near any heat sources such as radiators, heat registers, stoves, or other apparatus (including amplifiers) that produce heat.



9. Only use attachments / accessories specified by the manufacturer.



5. Do not place sources of naked flames, such as lighted candles, on the unit.



10. Refer all servicing to qualified service personnel.

Table of Contents

Introduction	3
Overview.....	3
Features	4
Package Contents	4
Specifications.....	5
Panel	7
<i>Transmitter EX0101-N131-000</i>	7
<i>Receiver EX0101-N141-000</i>	9
Typical Application	11
<i>One Transmitter to One Receiver</i>	11
<i>One Transmitter to Multiple Receivers</i>	12
<i>Multiple Transmitters to Multiple Receivers</i>	13
<i>Video Wall</i>	14
Hardware Installation	15
Operation	16
PC Control Tool.....	16
<i>Installation</i>	16
<i>Searching Devices</i>	18
<i>Setting Device Parameters</i>	20
<i>Scene Setting</i>	22
<i>Video-wall Setting</i>	25
<i>Manage Configuration Files</i>	34
<i>Log</i>	35
Upgrade.....	36
<i>Preparation</i>	36
<i>Upgrade instructions</i>	39
Troubleshooting	45
Product Service	48

Maintenance	48
Provided Service.....	48
<i>Mail-In Service</i>	48
<i>Warranty</i>	49
<i>Warranty Limits and Exclusions</i>	49
Glossary	51

Introduction

Overview

The HDMI over IP Extender allows you to simultaneously send out an HDMI 1.3 Signal (including 1080p video with 2.1 audio) to one or more HDMI video projectors or LCD Panels and return an IR control Signal to the source using CAT5e/6/7 Cable over a standard Ethernet infrastructure. Can be used to distribute HD digital content from multiple Sources to many remote distribute on a LAN by cascading Ethernet switches up to several levels, allowing the display very far away from the 1080p source devices while sustaining picture & sound quality. Each device is installed using 1 piece of twisted pair cable. AV signals are transmitted digitally over the CAT5e/6/7 cable with visual lossless. Internal video compression adapts to available network bandwidth if needed. The IR TX / RX function can be used to remotely control the HDMI source device from any receiver location. Support USB 2.0, USB signal will be passed through with the HDMI signal.

SCT-IPKVM-TX131



SCT-IPKVM-RX141



Features

- HDMI 1.3 compliant.
- Extend the transmission distance to at least 100 meters from the sources to the display at 1080p.
- The IR TX / RX function can be used to remotely control the HDMI source device from any receiver location.
- USB signal transmission, Support USB 2.0.
- RS232 control signal transmission.
- Supports all high definition resolutions: 1080p, 1080i and 720p.
- HDCP compliant.
- PoE

Package Contents

- 1 x Transmitter SCT-IPKVM-TX131.
- 1 x Receiver SCT-IPKVM-RX141.
- 1 x CD
- 2 x 12V DC Power Supply
- 3 x Phoenix Male Connector
- 4 x Mounting Ear

Specifications

Technical	
Data Rate	150Mbps Maximum
Maximum Distance	100 meters
I/O Connections	Transmitter 1 x USB (B type), 1 x RJ45 port, 1 x HDMI IN, 1 x HDMI OUT, 1 x RS232 (3.5 mm phoenix)
	Receiver 4 x USB (A type), 1 x RJ45 port, 1 x HDMI OUT, 1 x RS232, 1 x AUDIO OUT
Power Supply	12V DC, 5.5mm
Power Consumption	5Watts
Input Video Signal	1.2 volts p-p
Input DDC Signal	5 volts p-p (TTL)
Video Format Supported	DTV/HDTV; 1080P/1080i/720P/576P/480P/576i/480i
Output Video	HDMI 1.3+HDCP
Output Audio	Stereo
Operating Temperature	32°F to 95°F (0°C to 35°C) 10% to 90%, non-condensing

Technical

Storage Temperature	-4°F to 140°F (-20°C to 70°C) 10% to 90%, non-condensing
---------------------	-------------------------------------------------------------

General

Dimensions	140mmHx115mmWx25mmD /5.51"Wx4.53"Hx0.98"D
Mass (Main unit)	0.9Kg / 1.98lb (Pairs)
Certification	CE, FCC, RoHS

Panel

Transmitter SCT-IPKVM-TX131

Front Panel

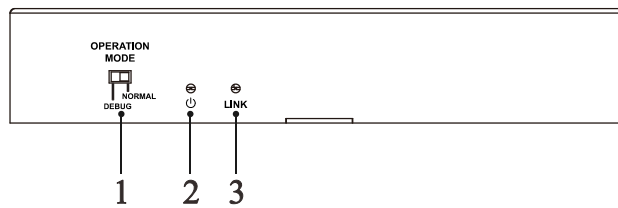
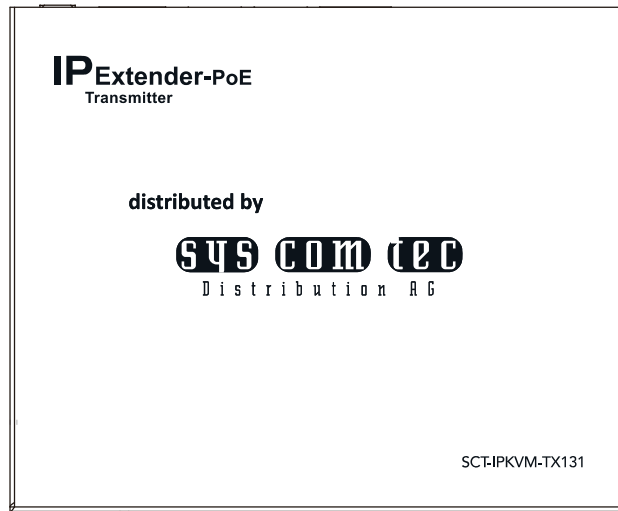

ID	Name	Description
1	Mode Switcher	Normal mode: transmit RS232 signal between TX and RX; Debug mode: debug the device.
2	Power LED	This LED glows steady red when the unit is powered on.
3	Link LED	This LED glows steady blue when the Transmitter and

ID	Name	Description
		Receiver are linked to each other.

Rear Panel

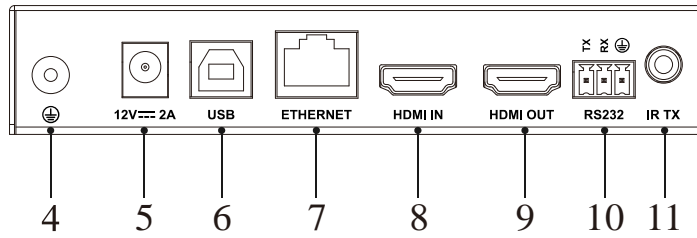

ID	Name	Description
4	GND	Grounding
5	Power	12V / 2A DC power supply input
6	USB	USB 2.0 port
7	ETHERNET	TCP/IP Connector
8	HDMI IN	Connect to HDMI source
9	HDMI OUT	HDMI Local By-pass Out
10	RS232	Connect to a RS232 device
11	IR TX	IR Transmitter port

Receiver SCT-IPKVM-RX141

Front Panel

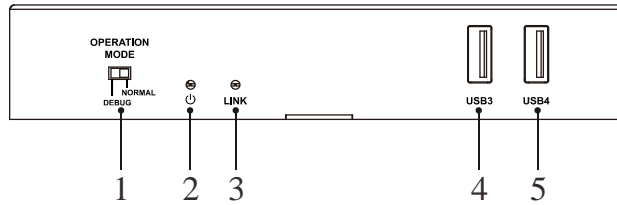
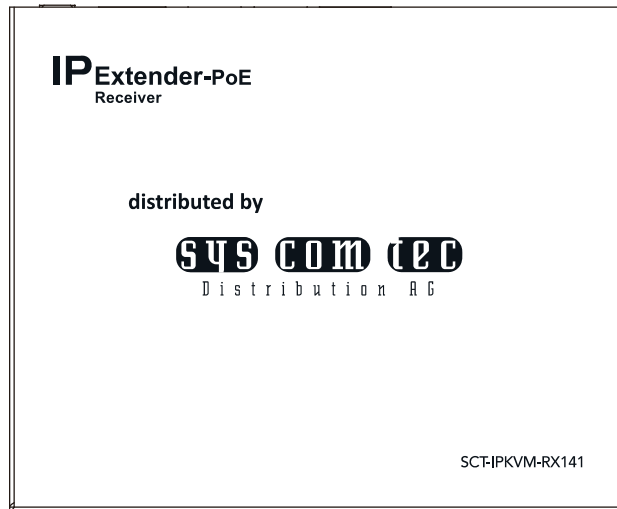

ID	Name	Description
1	Mode Switcher	Normal mode: transmit RS232 signal between TX and RX; Debug mode: debug the device.
2	Power LED	This LED glows steady red when the unit is powered on.
3	Link LED	This LED glows steady blue when the Transmitter and

		Receiver are linked to each other.
4	USB3	USB 2.0 port
5	USB4	USB 2.0 port

Rear Panel

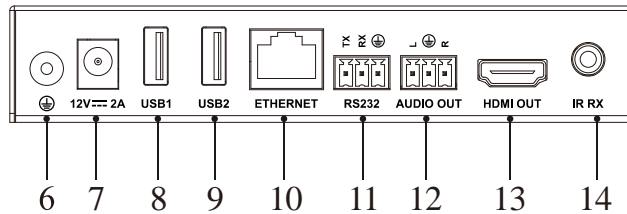

ID	Name	Description
6	GND	Grounding
7	Power	12V / 2A DC power supply input
8	USB1	USB 2.0 port
9	USB2	USB 2.0 port
10	ETHERNET	TCP/IP Connector
11	RS232	Connect to a RS232 device
12	AUDIO OUT	Audio break out
13	HDMI OUT	HDMI Local By-pass Out
14	IR RX	IR Receiver port

Typical Application

One Transmitter to One Receiver

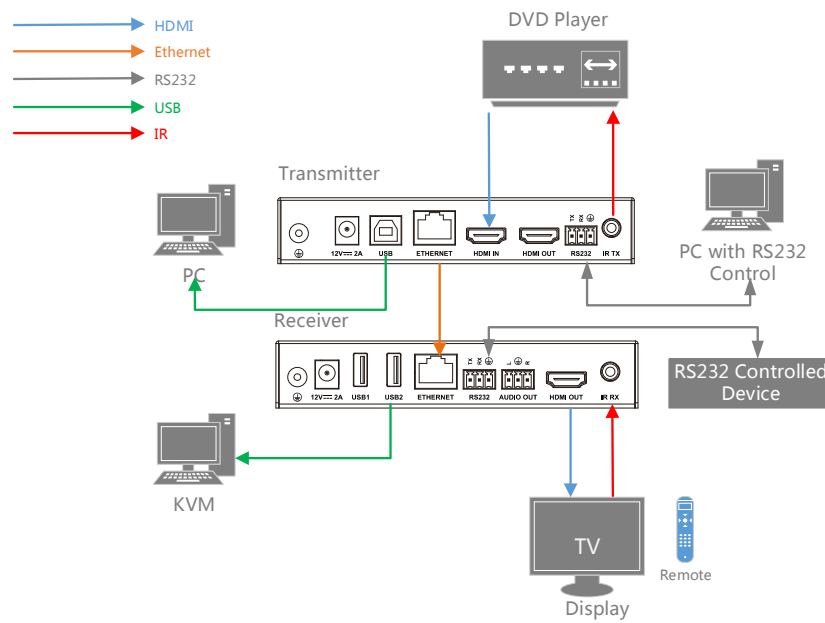

One Transmitter to Multiple Receivers

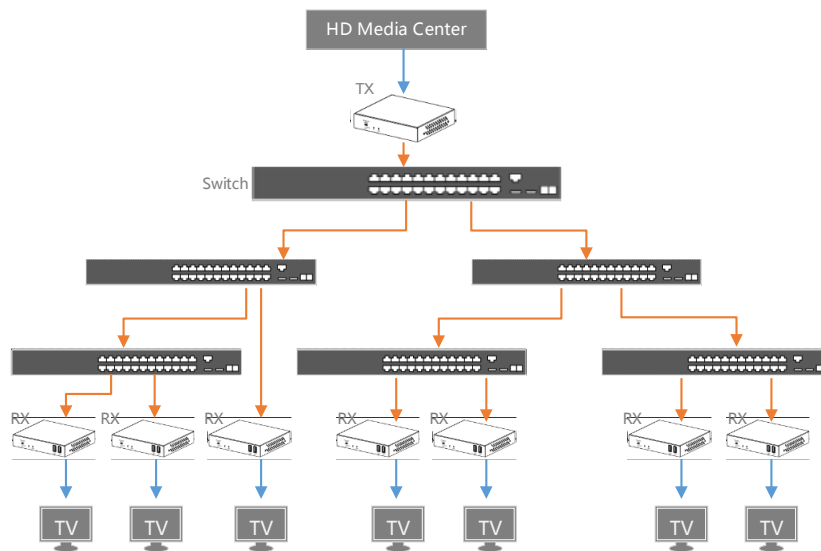

Multiple Transmitters to Multiple Receivers

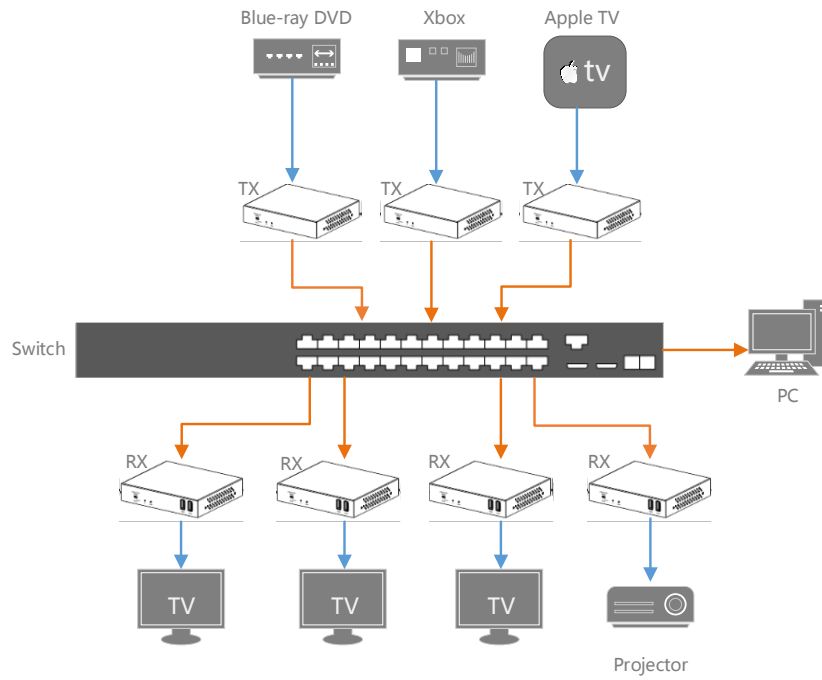

Video Wall

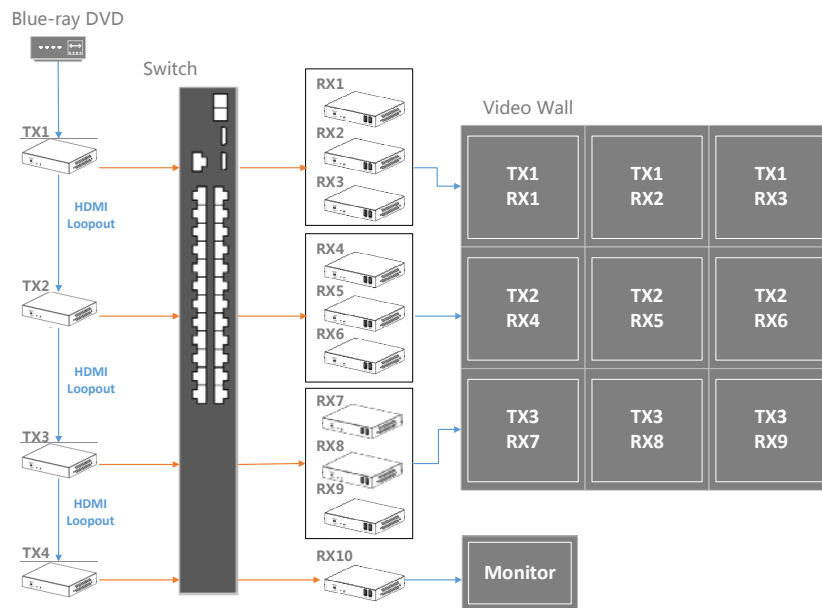

Hardware Installation

1. Connect HDMI source (such as a DVD player) to the transmitter SCT-IPKVM-TX131
2. Connect computer to the SCT-IPKVM-TX131 with USB cable.
3. Connect HDMI display (such as a plasma TV) to the receiver SCT-IPKVM-RX141
4. Plug USB device (such as keyboard, mouse etc.) to the USB jack of SCT-IPKVM-RX141.
5. Connect CAT-5/5e/6/7 cables between the transmitter and receiver, make sure CAT-5/5e/6/7 cables are tightly connected and not loose.
6. Plug in 12V DC power cord to the power jack of SCT-IPKVM-TX131 and SCT-IPKVM-RX141.

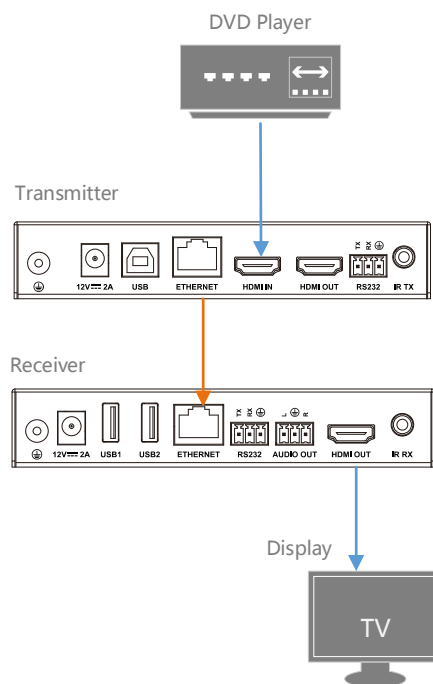

Operation

PC Control Tool

Installation

1. Obtain the installation package of the HDMI over IP configuration tool **HDMIoverIPConsole_V2.2.0.12.rar**. Double-click **HDMIoverIPConsole.exe** to start the tool.

Note:

The Operation System must be Windows XP or a later version.

You can control the device through the web management page of IP control box as well. For details, please refer to the User Manual of IP control box

2. Set a static IP on the computer, here take Window 7 as an example.

Step 1. Click **Start** menu, go to **Control Panel > Network and Sharing center > Change Adapter Settings > Local Area Connection**, right click it, choose **Properties**.

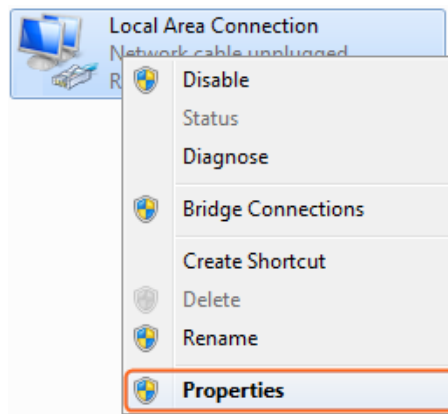

Step 2. Highlight **Internet Protocol Version 4 (TCP/IPv4)**, click **Properties**.

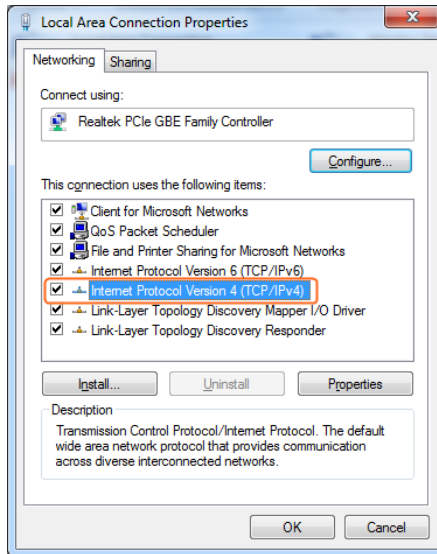

Step 3. Check **Use the following IP address**, the **IP address** enter 169.254.x.x (here take 169.254.2.5 as an example), the **subnet mask** enter 255.255.0.0. Click **OK**, then click **OK** again.

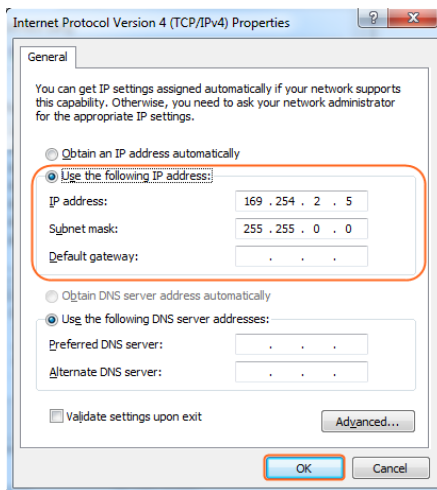

Searching Devices

Step 1. Click **Search** in the Device list area. The search is started.

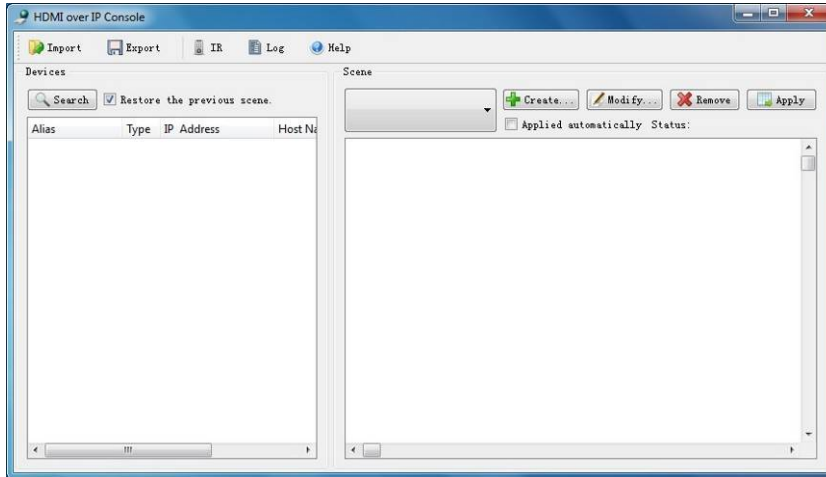

Step 2. Wait until the search is complete.

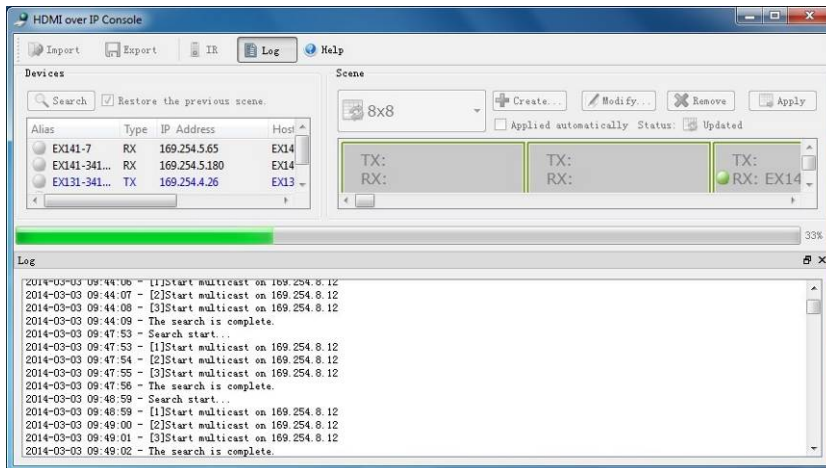

Step 3. After the search is complete, authenticated devices are displayed in the **Devices**. **Restore the previous scene** is checked by default.

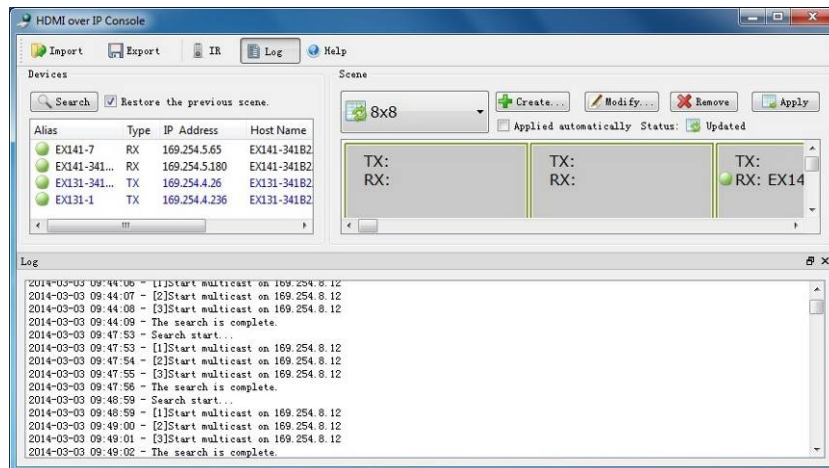

Note:

If the **Windows Security Alert** dialog box comes up, check both boxes and click **Allow access** (with Administration Authority)

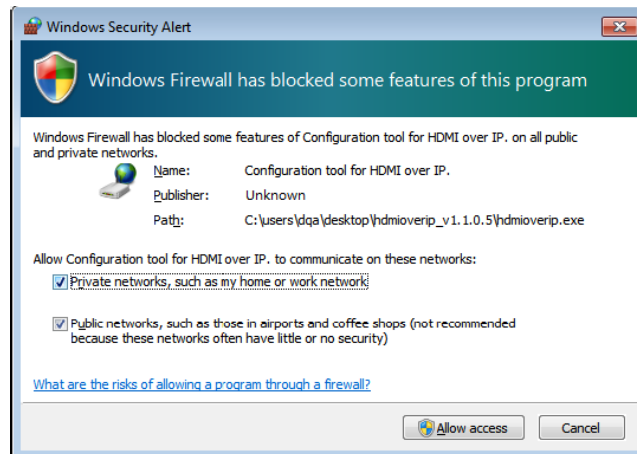

If no device is found, please refer to problem 1 in Troubleshooting.

Setting Device Parameters

Right click a device in **Devices**, all the authorized operations are displayed in the shortcut menu.

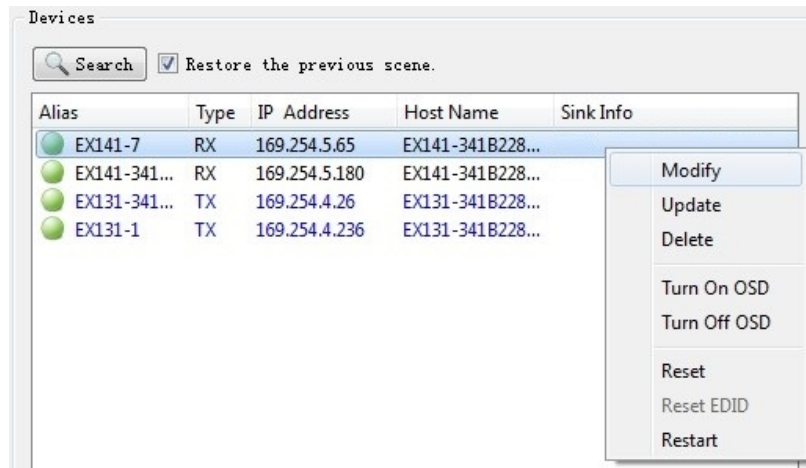

Operation	Description
Modify	Modify device parameters. This operation is valid only when a single device is selected.
Update	Update device status, such as Alias, Type, etc. This operation is valid when one or more devices are selected.
Delete	Delete the devices. This operation is valid when one or more devices are selected.
Turn On OSD	Turn on On-screen Display. On-screen Display identifies which device is connected to TX. For example, highlight a TX, choose Turn On OSD, the device which TX connected to will display "123456".
Turn Off OSD	Turn off On-screen Display.
Reset	Restore the device to factory settings. This operation is valid when one or more devices are selected. After

Operation	Description
	Reset , it's recommended to Delete and Search to search the device again
Reset EDID	Reset Extended Display Identification Data. This operation is valid when a TX device is selected.
Restart	Restart the device. This operation is valid when one or more devices are selected.

Device Settings

Right click a device in **Devices** and choose **Modify**, the **Device settings** dialog box is displayed.

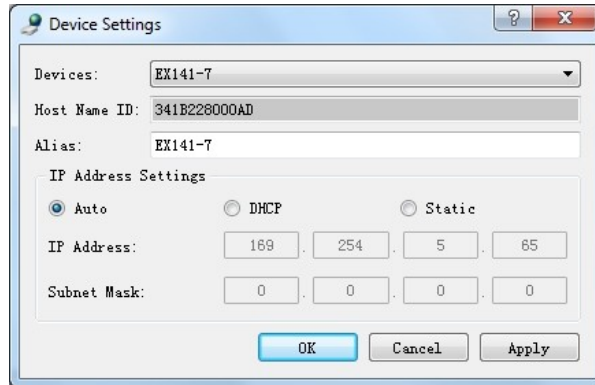

GUI Element	Description
Devices	The current device.
Host Name ID	The Host Name ID, which is generated by the system and cannot be changed.
Alias	The user-defined device name that contains a maximum of 80 characters.
IP Address	The device IP address, which can be set only when the static mode is selected.
Subnet Mask	The subnet mask for the device, which can be set only

GUI Element	Description
	when the static mode is selected.
Auto	Obtain the IP address automatically.
DHCP	The IP address is assigned by a router or switch.
Static	The IP address is manually configured. If you choose Static, enter 255.255.0.0 in Subnet Mask .

Restart the current device after performing any operation in the **IP address** area. If the IP address assignment mode is changed from **Static** to **Auto** or **DHCP**, re-search the device after it is restarted.



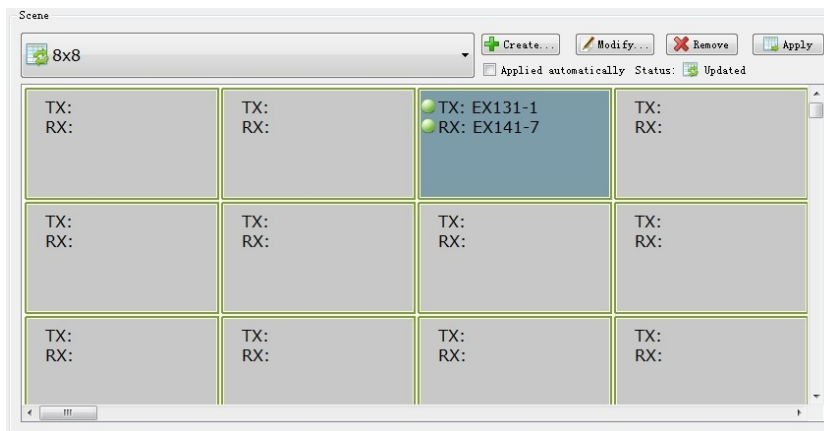

Scene Setting

Connecting Devices

The **Scene** displays the current status of devices.



GUI Element	Description
Create	Create a scene.
Modify	Modify the current scene.
Remove	Delete the current scene.
Apply	Apply the scene connection settings.

Applied automatically	Check this option, it automatically applied the settings. We recommend you check this option.
Status	<p>The status of the scene.</p> <ul style="list-style-type: none">  The matrix is restored.  In progress.  Apply settings successfully.  Failed to apply settings.

You can move the TX and RX from the left devices list to specific cells in the right table and apply the scene setting.

Modifying the Scene

After your click **Modify** in the Scene area, the Modify Scene dialog box is displayed.

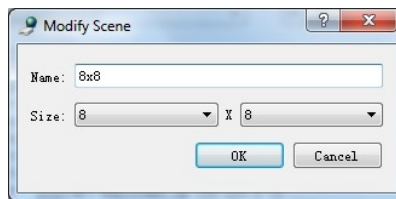

Give the scene a name, the maximum length is 80 characters.

Right click a cell, all the authorized operations are displayed in the shortcut menu.

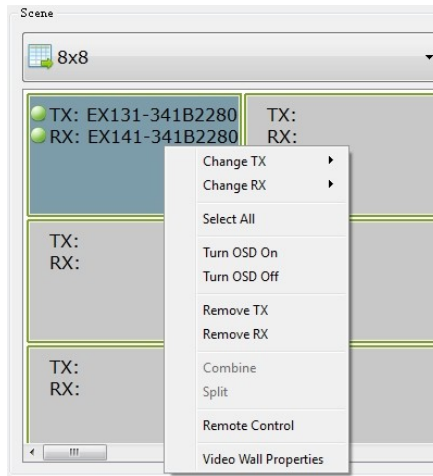

GUI Element	Description
Change TX	Change TX.
Change RX	Change RX.
Select All	Select all the cells in the Scene.
Turn OSD On	Turn on on-screen display.
Turn OSD Off	Turn off on-screen display.
Remove TX	Remove TX.
Remove RX	Remove RX.
Combine	This operation is valid when at least two boxes are selected. For details, refer to Video Wall Settings.
Split	This operation is valid when at least two boxes are selected. For details, refer to Video Wall Settings.
Remote control	IR remote control, not supported yet.
Video Wall Properties	This operation is valid when there are combined signals.

Video-wall Setting

The Video-wall combines multiple display (RX) devices to show a complete video source. Select multiple display devices in the scene setting interface, and combine the cells.

Follow these steps to configure the Video-wall, here we take a 2 x 2 scene as an example:

Preparation:

1. Two Transmitters SCT-IPKVM-TX131
2. Four Receivers SCT-IPKVM-RX141
3. A Switch with PoE
4. A HDMI source such as a Blue-ray DVD
5. Four display devices
6. Several HDMI cables and Ethernet cables

Hardware Connection:

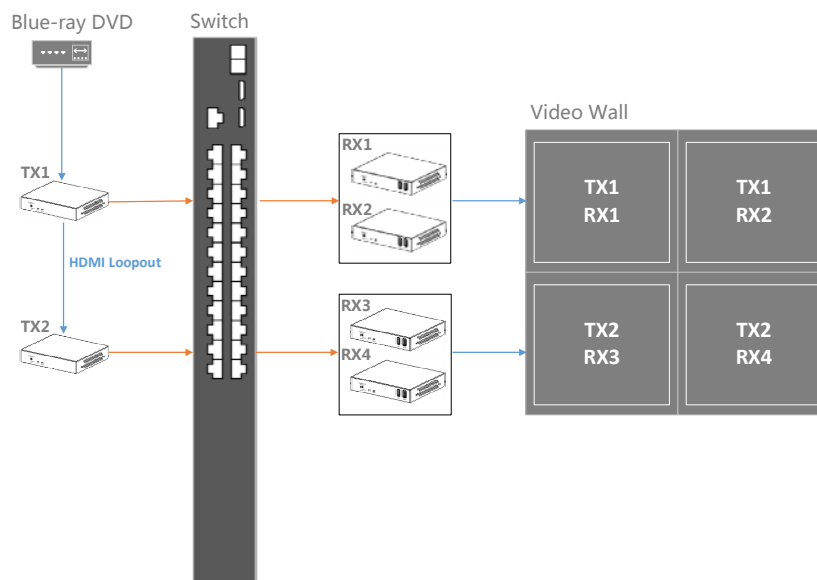

1. Connect the Blue-ray DVD to HDMI IN port of TX1 with a HDMI cable, connect HDMI OUT port of TX1 to HDMI IN port of TX2.
2. Connect TX1 and TX2 to the Switch with Ethernet cables.
3. Connect RX1, RX2, RX3, and RX4 to the Switch with Ethernet cables.
4. Connect HDMI OUT port of RX1, RX2, RX3, RX4 to the display devices with HDMI cables.
5. Power on all the devices

Note:

If the Switch doesn't support PoE function, please remember to plug in the power adapters of Transmitters/Receivers

Operation:

Step 1. Run HDMI over IP Console, click Search button.

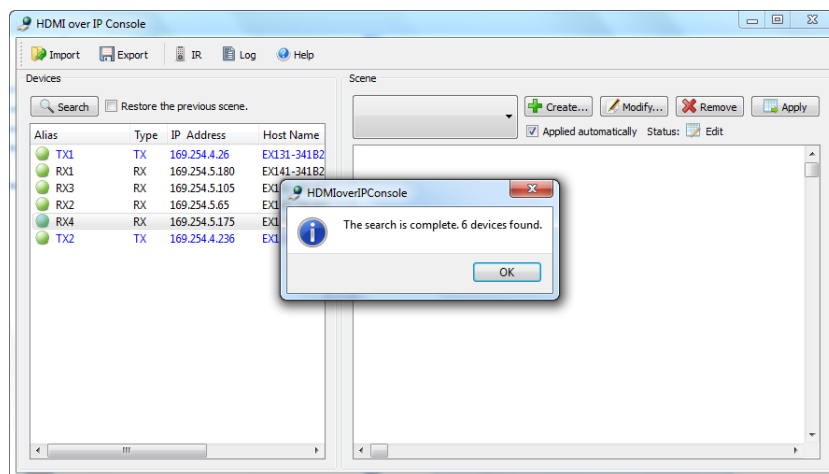

Step 2. Click **Create** button to create a 2 x 2 scene.

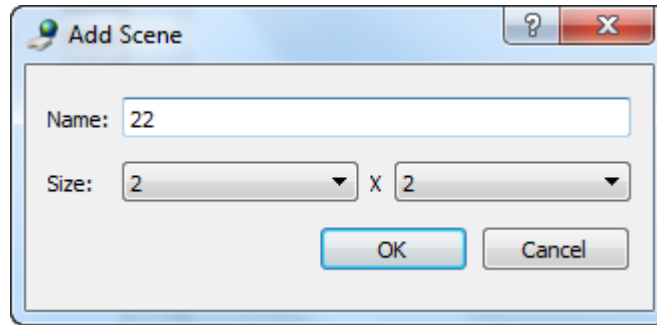

Click **OK**, a 2 x 2 scene comes up.

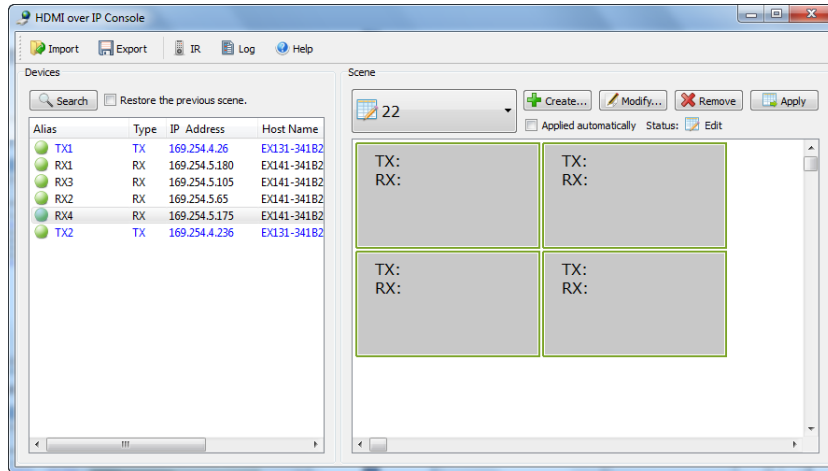

Step 3. Link the TX and RX. Highlight the first cell, right click it, choose **Change TX**, and click **TX1**. Then choose **Change RX**, click **RX1**.

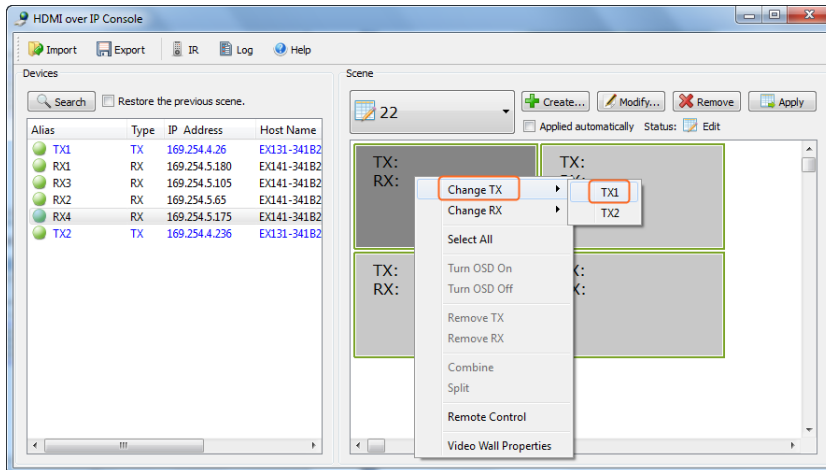

The rest can be done in the same way.

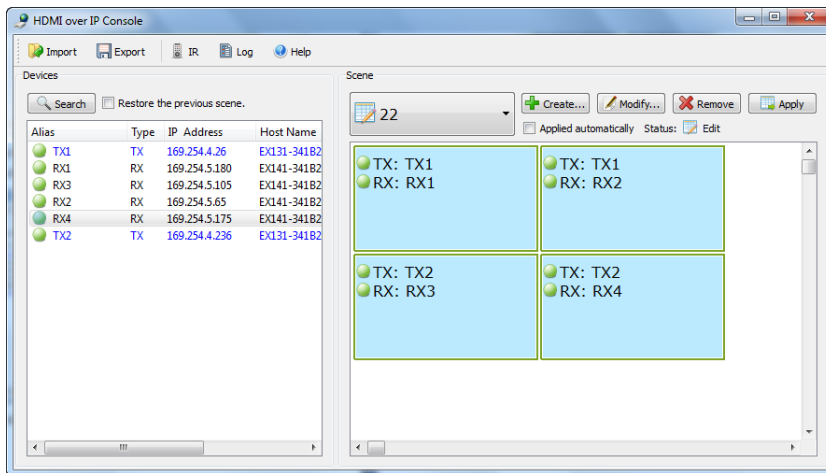

Step 4. Right click a cell, choose **Select All**.

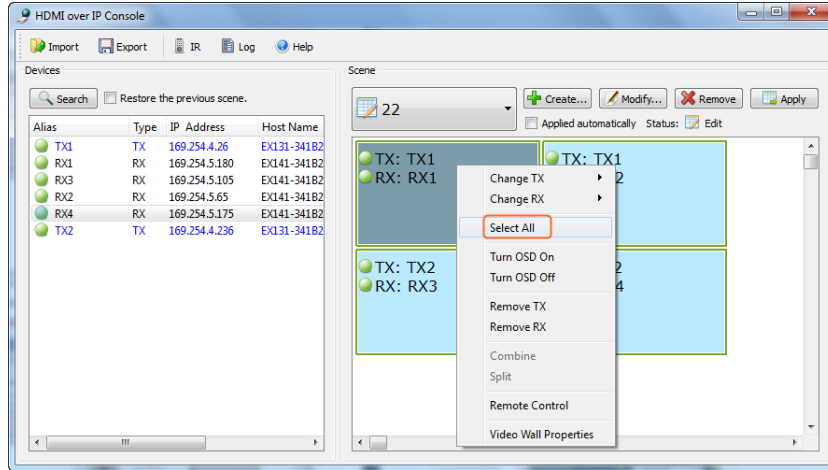

The color is different.

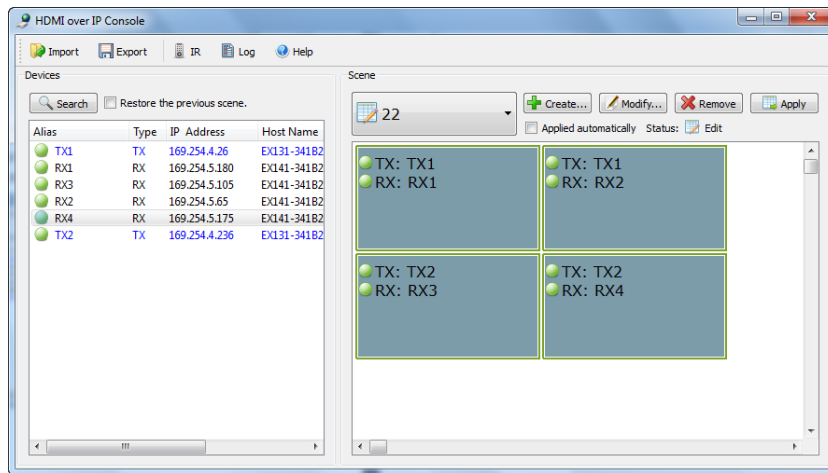

Step 5. Now right click the cells, choose **Combine**.

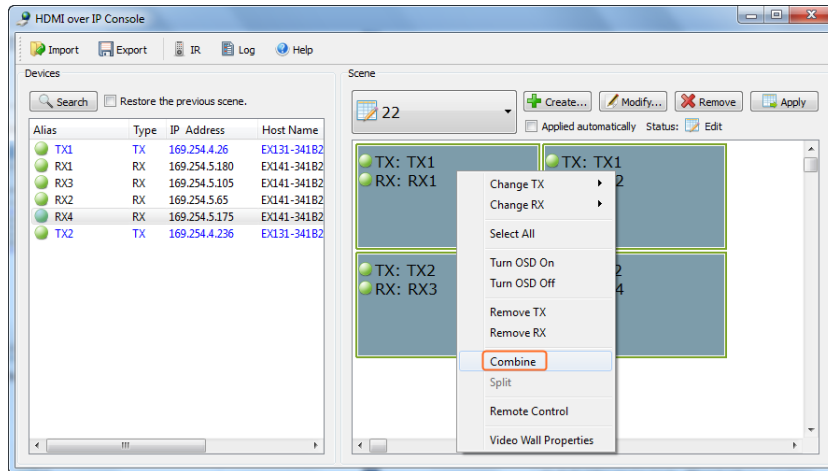

Step 6. You can see this page comes up. Check **Multi Host Mode**, input a name, and click **OK**.

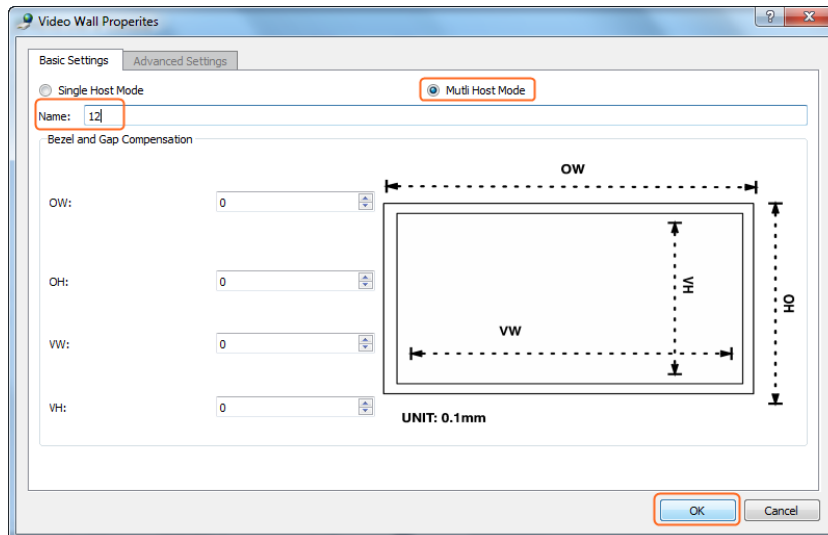

Step 7. You may notice that the TXs are incorrect, please choose the correct one.

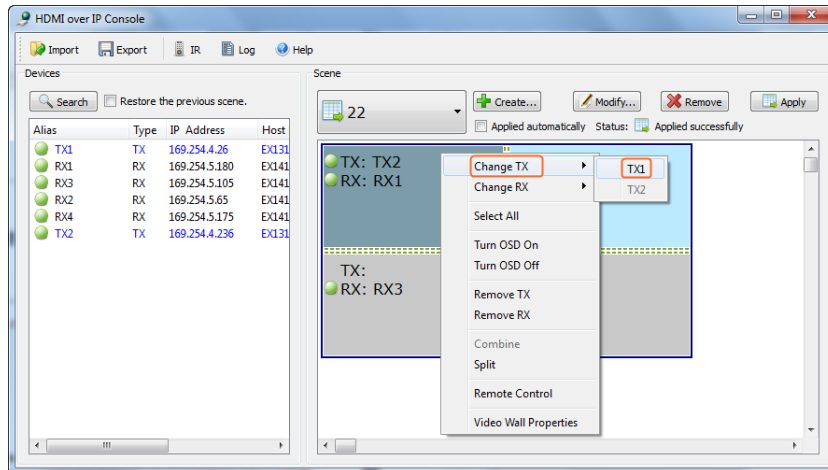

If **Applied Automatically** is not checked, please click **Apply** button, otherwise the combine doesn't take effect.

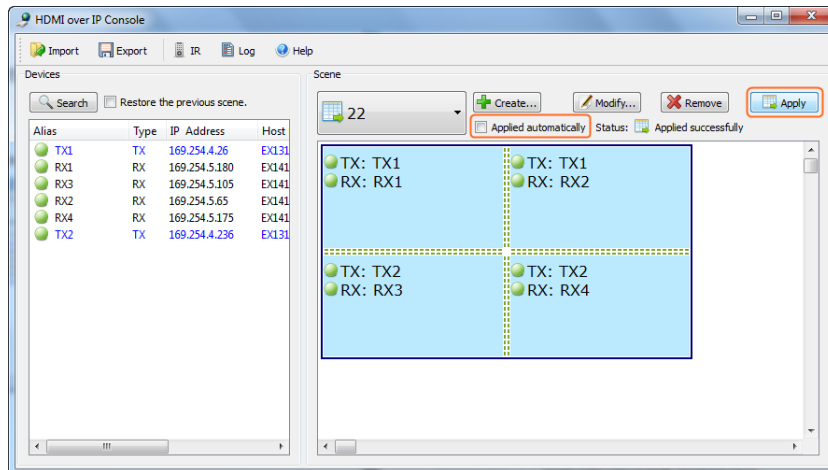

The Video-wall is configured successfully.

Video Wall Properties

Basic Settings

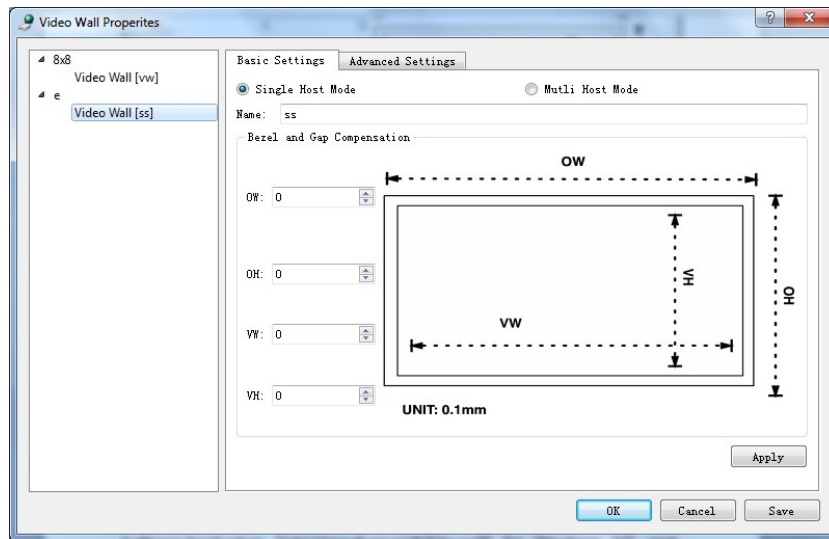

GUI Element	Description
Name	Give the Video Wall a name.
Single Host Mode	Single video-source mode, assign the same video-source to all cells.
Multi Host Mode	Multiple video-source mode, different cell rows could be assigned with different video sources. We recommend you check this mode.
OW, OH, VH, VW	set the Bezel and Gap Compensation of displays

We recommend you leave the settings as default value

Advanced Settings:

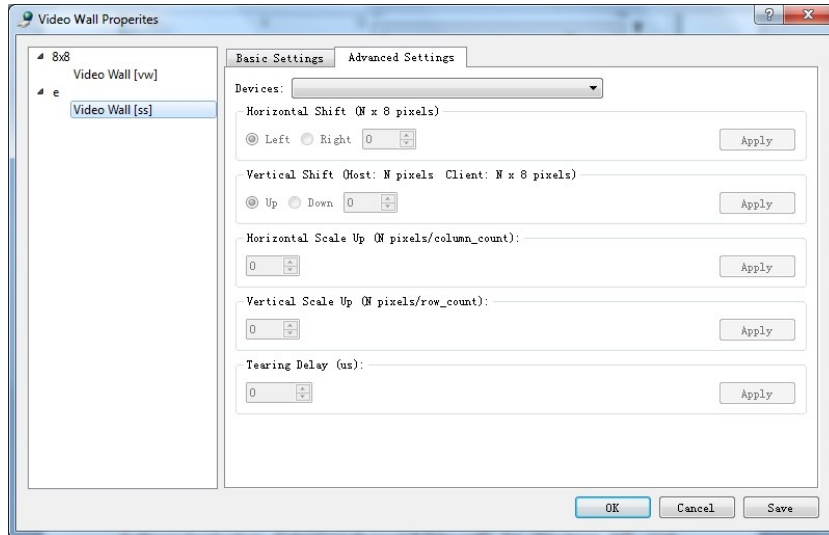

We recommend you leave the settings as default value.

Manage Configuration Files

Close the configuration tool, the windows would save a configuration file **default.hoi** in the current directory.

For windows XP, it is saved in

*C:\Documents and Settings\#user#\Local Settings\Application
Data\HDMloverIP*

For windows Vista or later version, it is saved in

C:\Users\#user#\AppData\Local\HDMloverIP

When start the tool next time, it would automatically read the configuration file **default.hoi**. Do not modify or delete the **default.hoi**. Otherwise, it may report error.

Note:

#user# means current user name of operation system.

In addition, you can click **Export** to save the configuration file to a specified directory, and click **Import** to import the configuration file from this directory.

Log

The log records the tool operation and device communication information, which can be used for troubleshooting.

```

Log
2014-03-17 00:02:29 - read param name="vw_moninfo_ht", value="vw_moninfo_ht" not defined.
2014-03-17 00:02:29 - Device(EX131-341B22800072) send data succeed [./astparam g vw_moninfo_va
]
2014-03-17 00:02:29 - Device(EX131-341B22800072) recv data ["vw_moninfo_ht" not defined/usr/local/bin # ./astparam g]
2014-03-17 00:02:29 - Device(EX131-341B22800072) recv data ["vw_moninfo_ht" not defined/usr/local/bin # ./astparam g vw_moninfo_va
vw_moninfo_va" not defined/usr/local/bin # ]
2014-03-17 00:02:29 - read param name="vw_moninfo_va", value="vw_moninfo_va" not defined.
2014-03-17 00:02:29 - Device(EX131-341B22800072) send data succeed [./astparam g vw_moninfo_vt
]
2014-03-17 00:02:29 - Device(EX131-341B22800072) recv data ["vw_moninfo_va" not defined/usr/local/bin # ./astparam g]
2014-03-17 00:02:29 - Device(EX131-341B22800072) recv data ["vw_moninfo_va" not defined/usr/local/bin # ./astparam g vw_moninfo_vt
vw_moninfo_vt" not defined/usr/local/bin # ]
2014-03-17 00:02:29 - read param name="vw_moninfo_vt", value="vw_moninfo_vt" not defined.
2014-03-17 00:02:29 - Device(EX131-341B22800072) send data succeed [./astparam g vw_v_shift
]
2014-03-17 00:02:29 - Device(EX131-341B22800072) recv data ["vw_moninfo_vt" not defined/usr/local/bin # ./astparam g]
2014-03-17 00:02:29 - Device(EX131-341B22800072) recv data ["vw_moninfo_vt" not defined/usr/local/bin # ./astparam g vw_v_shift
vw_v_shift" not defined/usr/local/bin # ]
2014-03-17 00:02:29 - read param name="vw_v_shift", value="vw_v_shift" not defined.
2014-03-17 00:02:29 - Device(EX131-341B22800072) send data succeed [cat /sys/devices/platform/display/monitor_info
]
2014-03-17 00:02:29 - Device(EX131-341B22800072) recv data ["vw_v_shift" not defined/usr/local/bin # cat /sys/devic
attached=
/usr/local/bin # ]
2014-03-17 00:02:30 - Device(EX131-341B22800072) is updated.
2014-03-17 00:02:30 - All devices are updated.
2014-03-17 00:02:30 - Start restoring scene...
2014-03-17 00:02:30 - The scene is restored.
2014-03-17 00:02:30 - The search is complete.

```

Upgrade

Warning:

Do not turn off power during upgrade processing, otherwise it may cause damage to the device.

Preparation

1. Install **BonjourSDKSetup.exe** on your computer.

Step 1. Run **BonjourSDKSetup.exe**, click **Next**.



Step 2. Choose **I accept the terms in the license agreement**, click **Next**.

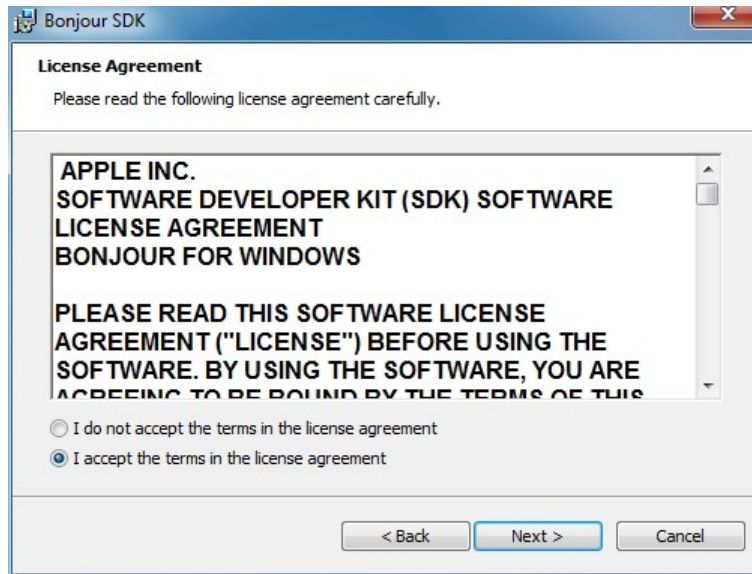

Step 3. Click **Next**.



Step 4. Click Install.

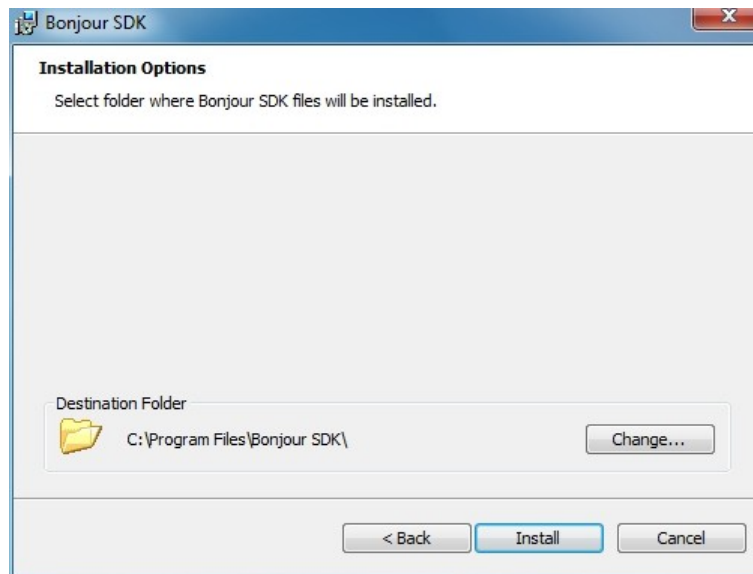

Step 5. Click Finish.

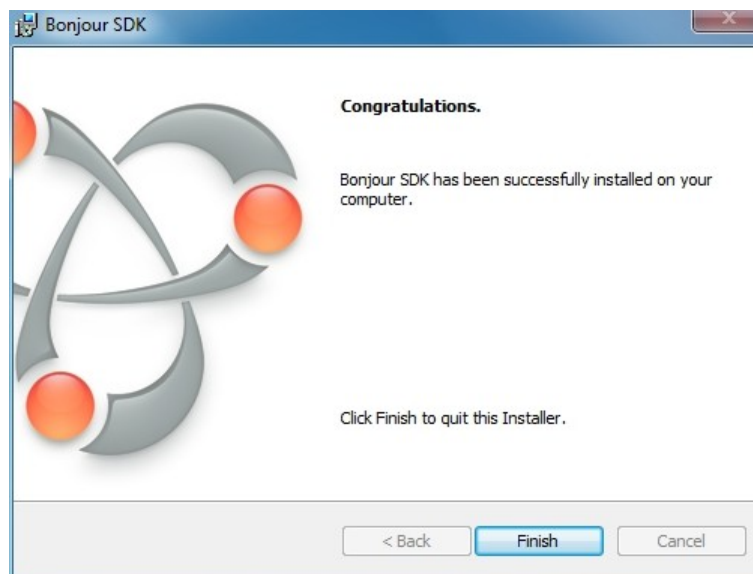

2. Set a static IP address on your computer.

Configure the IP address of the host. IP address is 169.254.x.x (take 169.254.11.11 as an example) , subnet mask is 255.255.0.0. Please refer to Operation.

Note:

Check the IP address (169.254.x.x) and subnet mask (255.255.0.0) every time before you upgrade, otherwise the device may unable to connect.

3. Prepare a gigabit switch (a megabytes switch is OK), connects to the power adapter.

Upgrade instructions

Step 1. Connect the device to the host with twisted pair (Cat 5 and above), or connect the device to a gigabit switch, then connect the gigabit switch to the host.

Step 2. Open Internet Explorer, go to **View > Explorer bars > Bonjour**

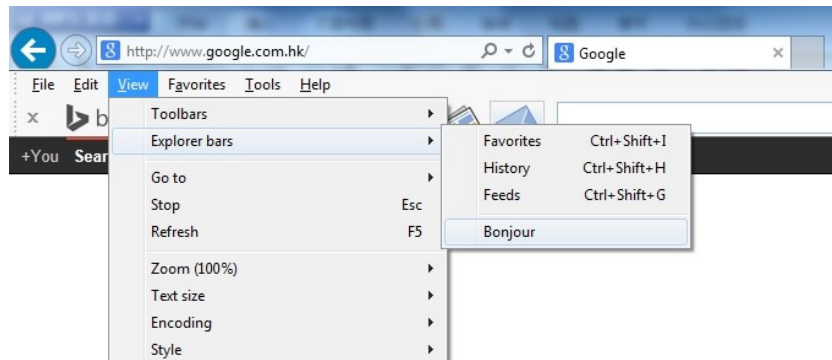

Step 3. Click the device name on the left side, goes into the web management page.

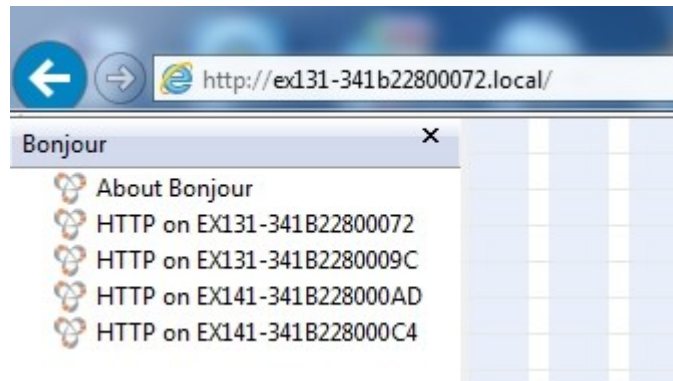

Step 4. Click **Update Firmware.**



Step 5. Click Browse....

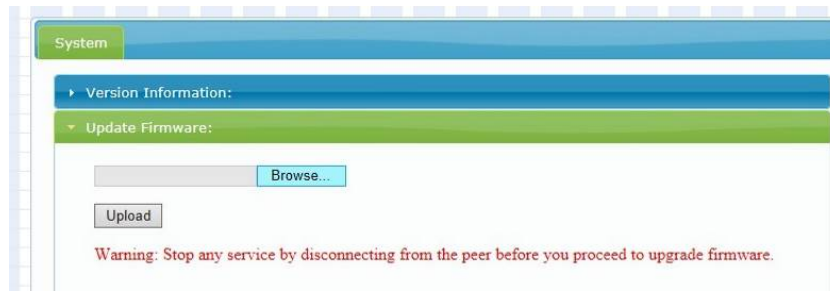

Step 6. Browse for the bin file. Choose EX0101-N131-000_web_vx.x.x.bin for N131, choose EX0101-N141-000_web_vx.x.x.bin for N141, and click Open.

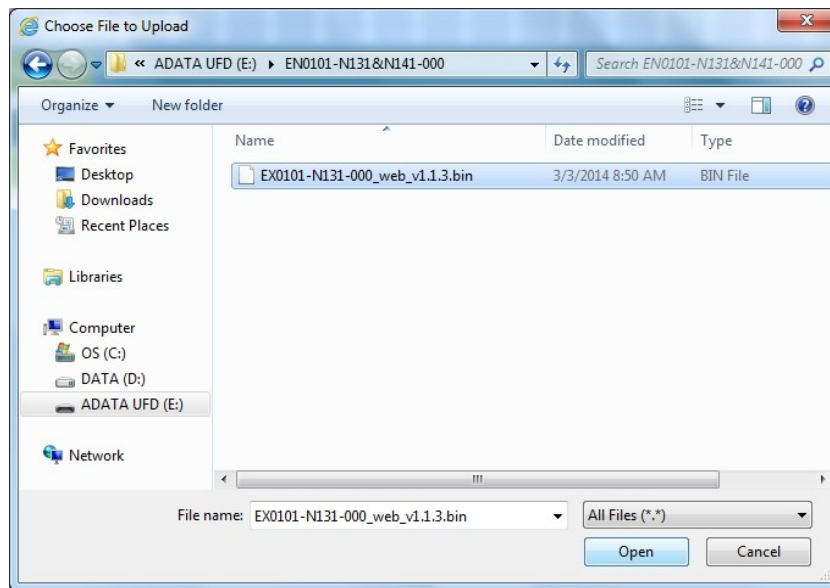

Step 7. Click **Upload**, it starts to upgrade.



Step 8. After a few moments, the Web interface will indicate that the upgrade process has been started.

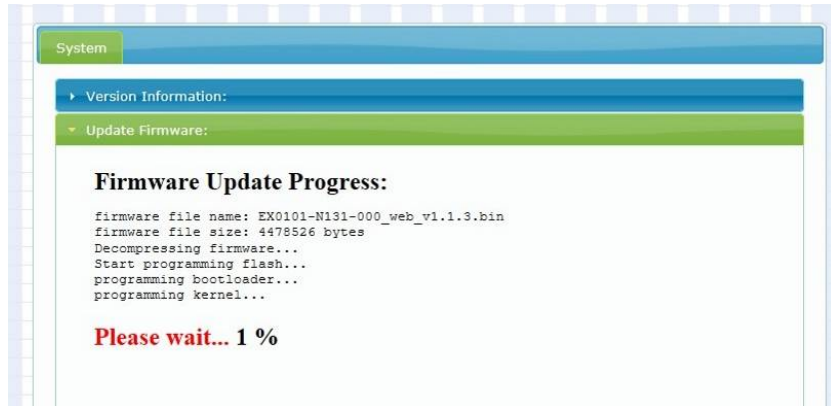

Once the firmware upgrade process has completed, the device will reboot.

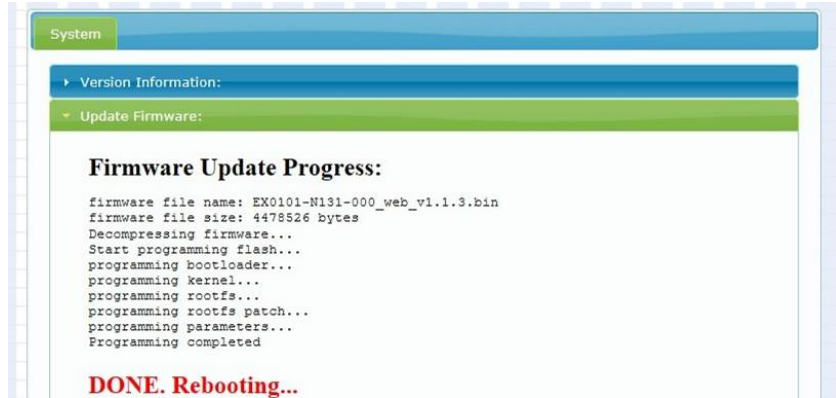

Step 9. Repeat the process for each Transmitter and Receiver unit in the system.

Note:

The upgrade may take several minutes, it is highly recommended to upgrade by a gigabit switch with several devices connected.

Reset

Step 1. Open **Internet Explorer**, goes into the web management page.

Step 2. Click **Utilities**.



Step 3. Click **Factory Default**, restore the device to factory default settings.

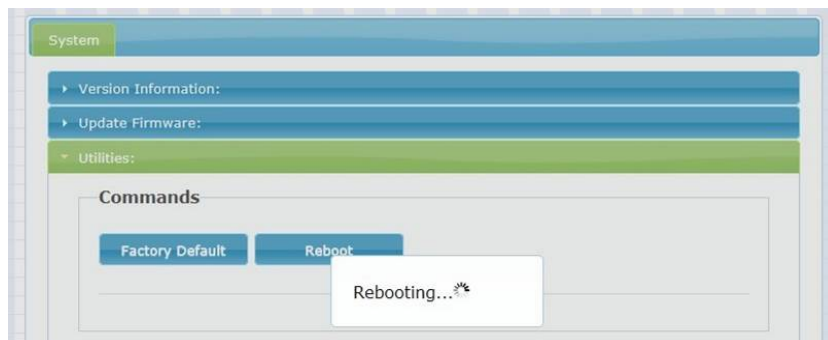

When **Rebooting** disappears, it means the device successfully restores to factory default settings.

Troubleshooting

1. Why HDMI over IP console cannot find any devices?

- 1) Check Windows Firewall. Take Windows 7 as an example: Click **Start** menu, go to **Control Panel > System and Security > Windows Firewall > Allowed Programs**, highlight **Configuration tool for HDMI over IP**, check **Home/Work (Private)** and **Public**.

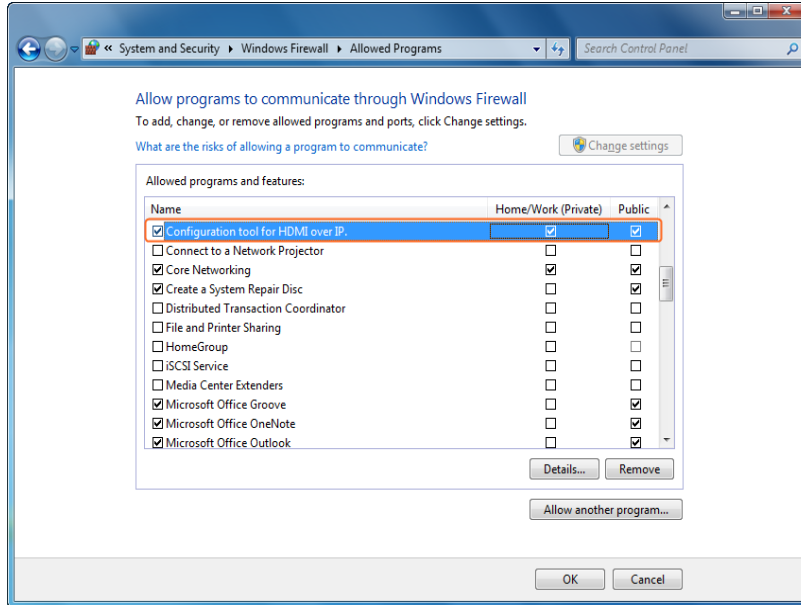

- 2) Check the IP address and subnet mask of the PC. The network segment for IP address is 169.254.x.x and the subnet mask is 255.255.0.0, the PC and Transmitter/Receiver should be in the same network segment. For details, please refer to **PC control tool** in chapter **Operation**.
- 3) Check the IGMP Snooping status in Switch. This function should be enabled.

2. Why TV shows no picture with RX connected?

Check the following items:

- All devices are powered on.
- A picture is achieved when connecting the source directly to the TV.
- TV has switched to the right signal source input mode using your TV remote, such as switching to HDMI 1 if HDMI 1 interface is connected to the RX via a HDMI cable.
- All the cables are qualified.
- The Switch supports IGMP snooping and this function is enabled.
- Error messages may be displayed at the bottom of the screen, here are some solutions:

Message	Possible Causes	Solutions
Remote IP: unknown	RX is restored to default settings.	Configure TX and RX through HDMI over IP console.
	RX is being rebooted.	Wait until RX is rebooted to view the picture.
No instructions are displayed	Poor cable connection to RX or TV	Insert the HDMI cable into RX or TV again.
Waiting for video source - standby	Poor cable connection to TX or input source.	Insert the HDMI cable into TX or input source again.
Network link is down	Poor cable connection to RX or switch.	Insert the network cable into RX or switch again.
Trying to find the transmitter	The RX is trying to find the Transmitter.	Wait until the picture is displayed.
	Poor cable connection to TX	Insert the network cable into the TX again.

Message	Possible Causes	Solutions
	TX/RX is not linked.	Configure TX and RX through HDMI over IP console.

Note:

For more information, please refer to *HDIP Product FAQ*.

Product Service

Maintenance

Clean this unit with a soft, dry cloth. Never use alcohol, paint thinner or benzine to clean this unit.

Provided Service

1. **Damage Requiring service:** The unit should be serviced by qualified service personnel if:
 - The DC power supply cord or AC adapter has been damaged;
 - Objects or liquids have gotten into the unit;
 - The unit has been exposed to rain;
 - The unit does not operate normally or exhibits a marked change in performance;
 - The unit has been dropped or the cabinet damaged.
2. **Servicing Personnel:** Do not attempt to service the unit beyond that described in these operating instructions. Refer all other servicing to authorized servicing personnel.
3. **Replacement parts:** When parts need replacing ensure the service uses parts specified by the manufacturer or parts that have the same characteristics as the original parts. Unauthorized substitutes may result in fire, electric shock, or other hazards.
4. **Safety check:** After repairs or service, ask the service to perform safety checks to confirm that the unit is in proper working condition.

Mail-In Service

When shipping the unit, carefully pack and send it prepaid, adequately insured and preferably in the original carton. Include a letter detailing the complaint and provide a daytime phone and/or email address where you can be reached.

If repair is needed during the limited warranty period the purchaser will be required to furnish a sales receipt/proof of purchase indicating date of purchase, amount paid and place of purchase. Customer will be charged for the repair of any unit received without such proof of purchase.

Warranty

If your product does not work properly because of a defect in materials or workmanship, syscomtec Distribution AG (referred to as “the warrantor”) will, for the length of the period indicated as below, (Parts (2) Years, Labor(90) Days) which starts with the date of original purchase (“Limited Warranty period”), at its option either (a) repair your product with new or refurbished parts, or (b) replace it with a new or a refurbished product. The decision to repair or replace will be made by the warrantor.

During the “Labor” Limited Warranty period there will be no charge for labor. During the “Parts” warranty period, there will be no charge for parts. You must mail-in your product during the warranty period. This Limited Warranty is extended only to the original purchaser and only covers product purchased as new. A purchase receipt or other proof of original purchase date is required for Limited Warranty service.

Warranty Limits and Exclusions

1. **This Limited Warranty ONLY COVERS failures due to defects in materials or workmanship, and DOES NOT COVER normal wear and tear or cosmetic damage.** The Limited Warranty ALSO DOES NOT COVER damages which occurred in shipment, or failures which are caused by products not supplied by the warrantor, or failures which result from accidents, misuse, abuse, neglect, mishandling, misapplication, alteration, faulty installation, set-up adjustments, maladjustment of consumer controls, improper maintenance, power line surge, lightning damage, modification, or service by anyone other than a Factory Service Center or other Authorized

Service, or damage that is attributable to acts of God.

2. **There are no express warranties except as listed under “limited warranty coverage”. The warrantor is not liable for incidental or consequential damages resulting from the use of this product, or arising out of any breach of this warranty.** (As examples, this excludes damages for lost time, cost of having someone remove or re-install an installed unit if applicable, travel to and from the service location, loss of or damage to media or images, data or other recorded content. The items listed are not exclusive, but are for illustration only.)
3. **Parts and service, which are not covered by this limited warranty, are your responsibility.**

Glossary

Acronym	Complete Term
DHCP	Dynamic Host Configuration Protocol
DTV	Digital Television
EDID	Extended Display Identification Data
HD	High Definition
HDCP	High-bandwidth Digital Content Protection
HDMI	High Definition Multimedia Interface
HDTV	High Definition Television
IR	Infra-red
OSD	On Screen Display
PoE	Power over Ethernet
RX	Receiver
TX	Transmitter

syscomtec Distribution AG

Adresse:

Raiffeisenallee 8
82041 Oberhaching / Germany

Tel: +49 (0)89 666 109 330
Fax: +49 (0)89 666 109 339
post@syscomtec.com

www.syscomtec.com